

【 W36 × D54 】

- ・ユニット数:6
- ・日除け面積:20.0㎡

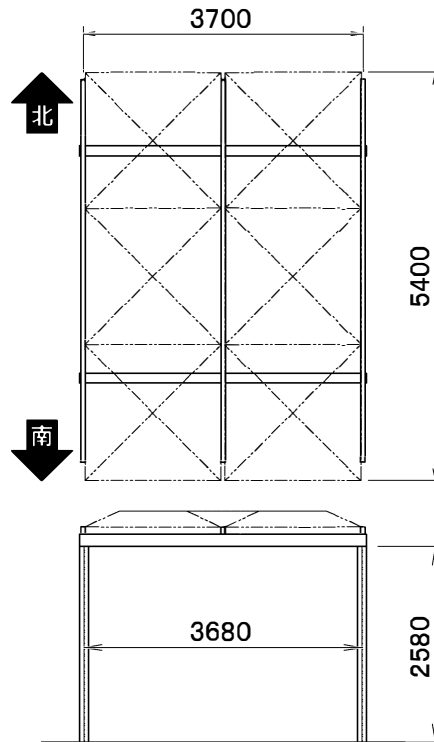
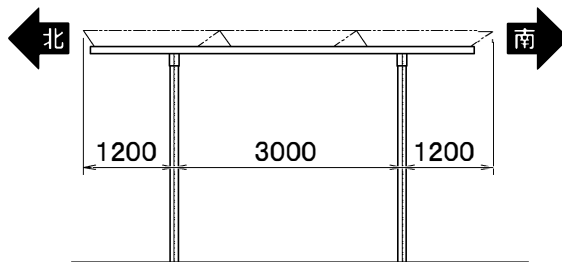

【 W36 × D36 】

- ・ユニット数:4
- ・日除け面積:13.3㎡

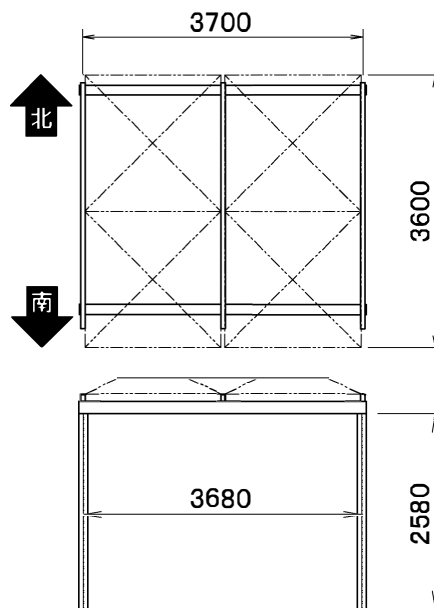
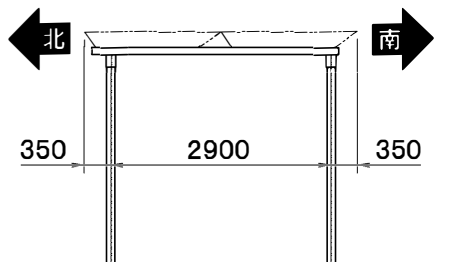

【 W36 × D18 】

- ・ユニット数:2
- ・日除け面積:6.7㎡

